

FIG. 4A

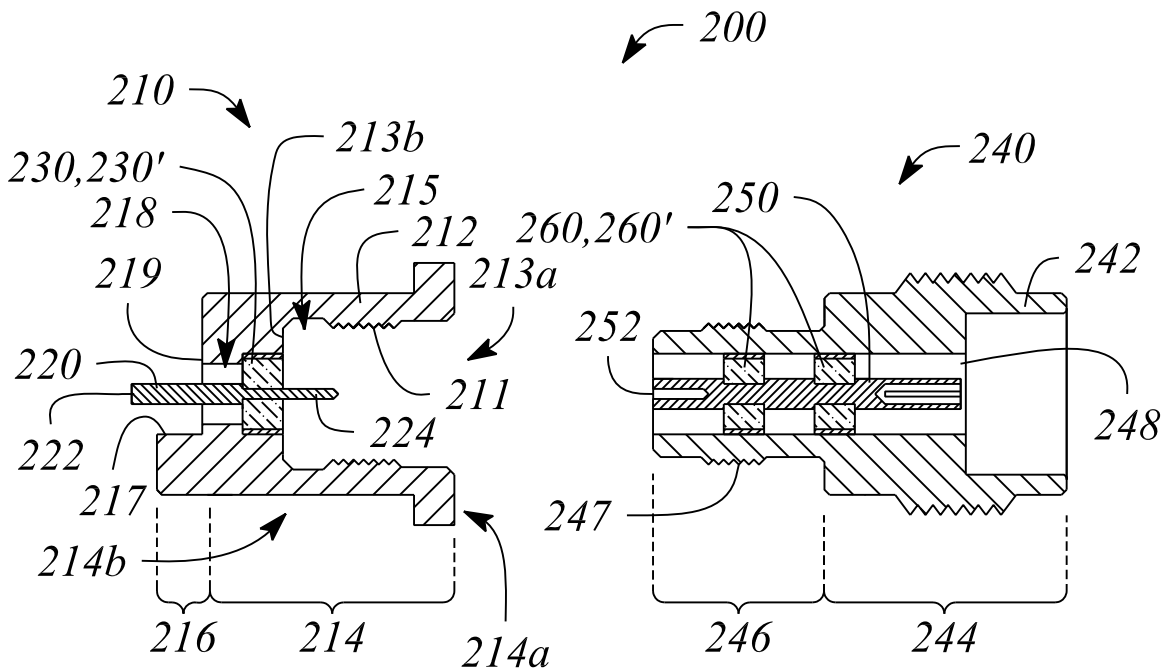

FIG. 4B

